

CIDRON

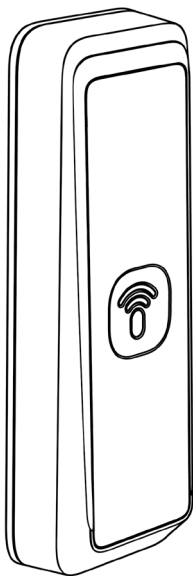



Installation guide

Cidron Slimline E Reader

2

Cidron Slimline E (VGE) Reader

- Technical specifications

Operating frequency	13,56MHz.
Reading technologies	MIFARE® CSN 4 byte, MIFARE® CSN 7 byte, MIFARE Classic®, MIFARE Plus, MIFARE® DESFire® 0.6 and MIFARE® DESFire® EV1. Also supports other ISO 14443 A/B* compatible cards. <i>*Not all ISO14443 B cards have been implemented in the reader, please contact Seriline for more details on current status. MIFARE is a registered trademark of NXP</i>
Communication protocols	<i>B.V. and is used under license.</i> Wiegand and RS232.
Reading output format	24-64 (excluding parity bits)
Indicators	LED, Green, Red and Yellow (Bi-color). Backlight in blue color. Buzzer.
Power supply	9 – 12VDC
Current consumption	12VDC, idle mode 35 mA** 12VDC, peak draw 92 mA (LED Bar setting =low, Backlight setting = low)** 12VDC, peak draw 114 mA (LED Bar setting =low, Backlight setting = low)**
Operating temperature	-20° – +60°C When installing readers in environments with extreme heat (above + 50°C) it is recommended to utilize the climate protection SC9901-V which provides additional shading to the reader.
Operating humidity	0 – 95% RHNC (Relative Humidity No Condensation)
Ingress Protection Classification	IP 65
Housing dimension	L = 141mm, H25mm, W=48mm
Configuration Methods	Configuration card, reader tool software or factory configured readers.
Compliances	  

**Current draw differs depending on functionality used and can also be limited in the reader configuration.

Current draw (idle) is defined as reader connected to power, no LED's lit, buzzer is not sounding and no reading of credential or key pressing is processed by the reader. Current draw (peak) is defined as reader powered with both backlight and LED frame lit (Yellow), buzzer is sounding and reader is reading a credential while simultaneously a key pressing is processed.

3

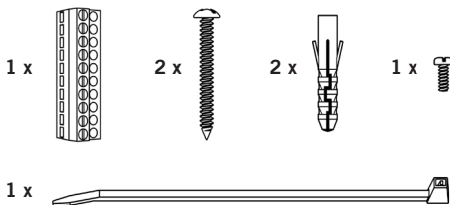
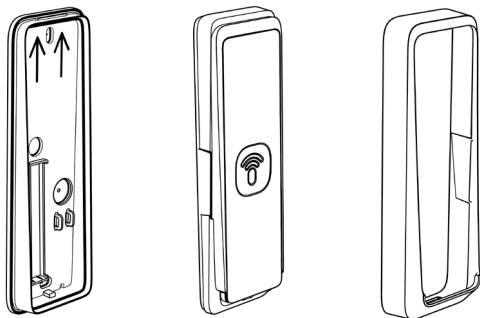

Package content:

- 1pc Installation plate
- 1pc Reader module with front plate
- 1pc Front cover
- 1pcs Terminal connector (10-pin)
- 2pcs Installation screws
- 2pcs Screw plugs
- 1pc Cable strip
- 1pc Fixing screw
- 1pc Quick installation guide

* Please note that all pictures in this manual are illustrations and do not represent the actual sizes and form of the components.

4

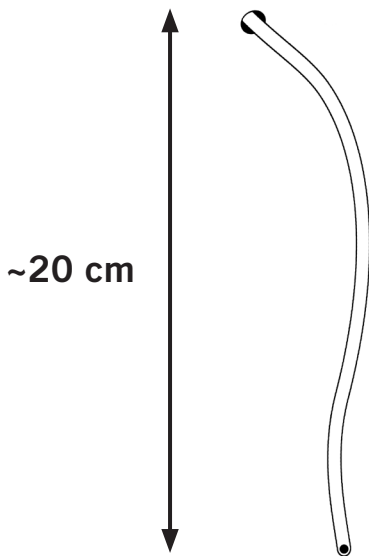

In order to facilitate installation a cable length of 20cm is recommended.

5

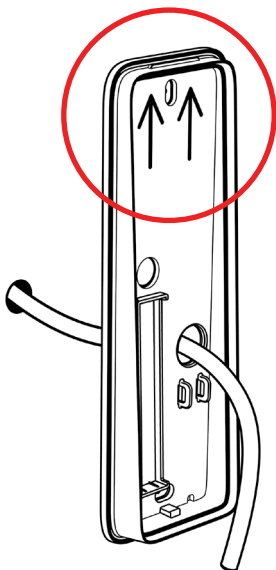

Ensure that the installation plate is fixed in the correct direction, i.e. the arrows pointing upwards.

6

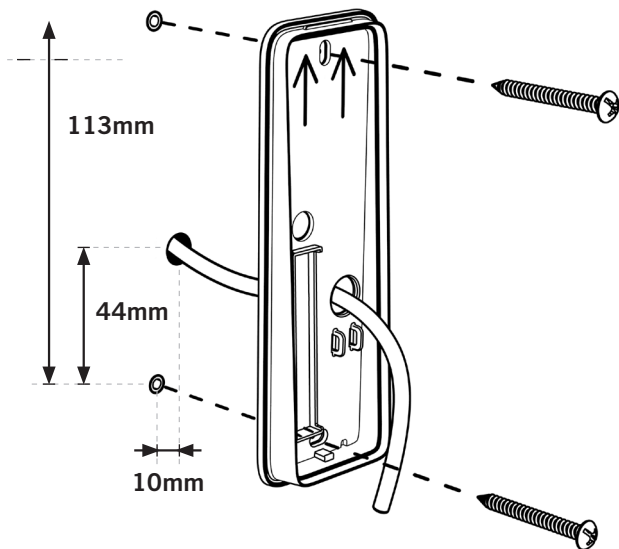

When installing directly to wall or door, use the installation holes as picture describes. If using other screws than the ones supplied with the reader, make sure to use a flat headed screw with a maximum height of 2.8 mm and a maximum diameter of 7.8 mm on the screw head.

Make sure not to tighten the screws too hard as doing so will deform and skew the installation plate. Countersunk screws should never be used.

7

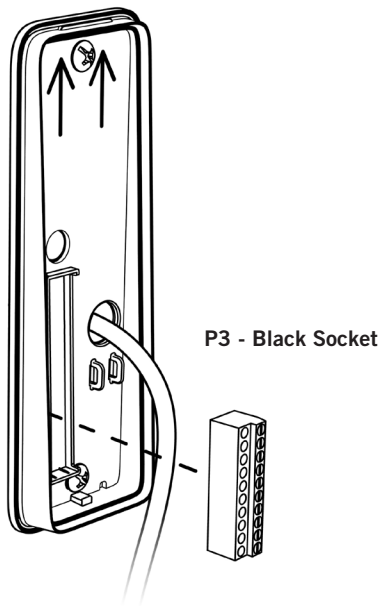

Make sure to place the terminal connector with the fastening screws facing towards you.

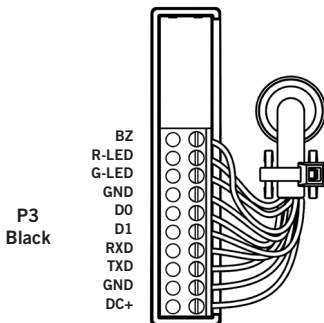

	PIN	Description	Wiegand	RS232
P3 - Black	BZ	External Buzzer control	x	-
	R-LED	External Red LED control	x	-
	G-LED	External Green LED control	x	-
	GND	Ground	-	-
	D0	Wiegand Data1	x	-
	D1	Wiegand Data0	x	-
	RXD	RS232 -	-	x
	TXD	RS232 +	-	x
	GND	Ground	x	x
	DC+	Power supply 9-12 VDC	x	x

1. Maximum wiegand cable length is 150 meters and requires a high quality shielded cable with minimum AWG18 dimension (=0.8231mm²) in an environment free from electrical noise.
2. Wiegand requires dedicated wires for external control of green LED, red LED, buzzer and keypad backlight LED.

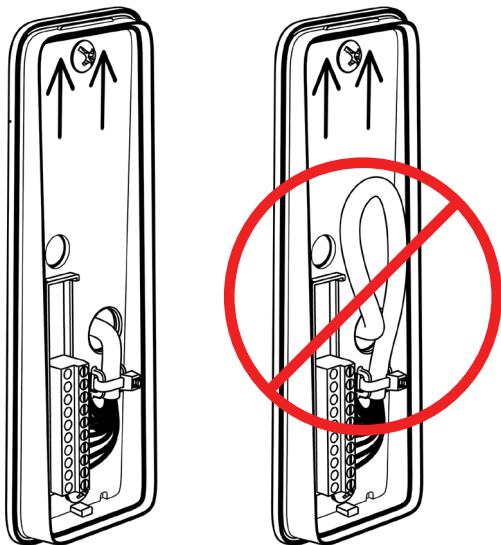

Make sure no excess connection cable is left in between the reader module and the installation plate.

Use the enclosed cable strip to fix the cable in the cord grip. It is recommended to connect the the wires to the terminal connectors before tightening the cable strip.

10

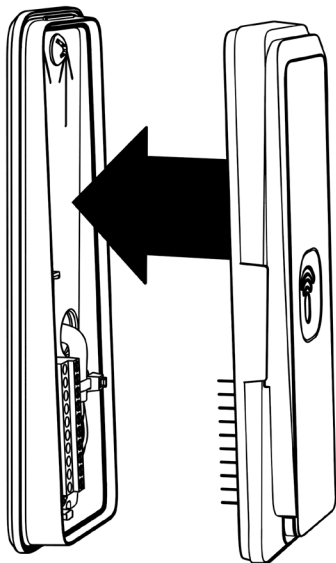

When installing the reader to the mounting plate ensure that the reader pin header contact perfectly aligns with the terminal connector block.

11

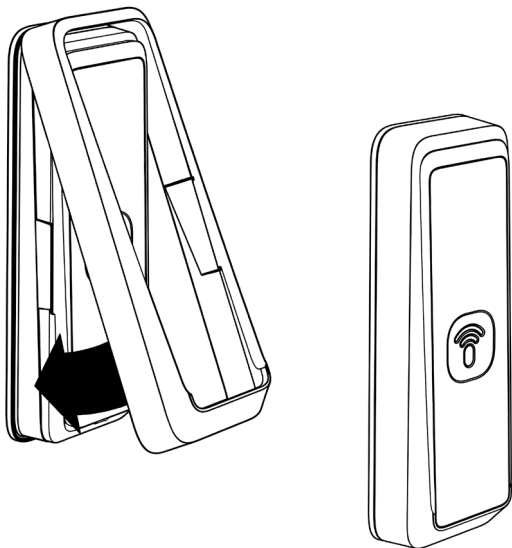

Mount the front cover as per the image above and make sure it is fitted correctly.

In order to do so, align and fit the top snap fastening, apply and maintain pressure on the top of the front cover while sliding the front cover over the bottom snap fastening.

12

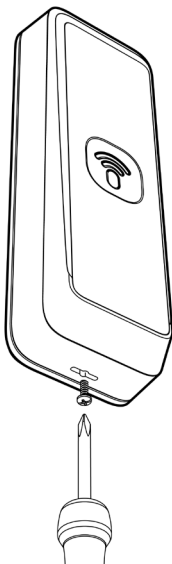

To secure the front cover to the reader use the supplied fixing screw and fix it into the installation plate through the front cover.

13

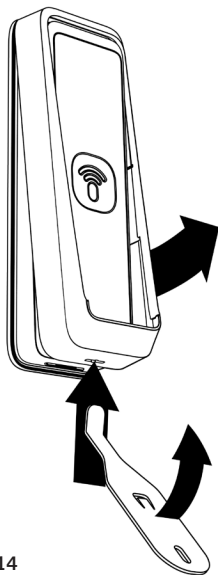

Cidron tool, part no: SC9914

To open the reader, first remove the fixing screw and then detach the front cover from the installation plate by inserting the tip of the tool into the slot at the bottom of the front cover and move the tool upwards. This will release the front cover without damaging the front cover and/or the installation plate.

14

Overview, programming of reader

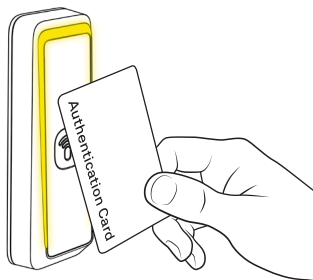

Setting the reader in programming mode

see page: **15**

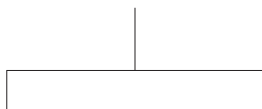

**Configuring the
reader**

see page: **16**



**Changing
authentication card**

see page: **17**

15

Setting the reader in programming mode

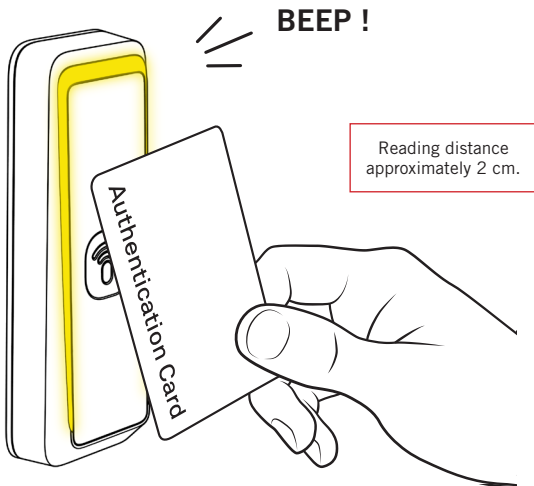

In order to set the reader in programming mode, present the valid “Authentication Card” to the reader as shown. The reader will beep and start blinking yellow to indicate that it is now in programming mode.

The Reader is in programming mode for 10 seconds. If no other programming card is presented within this time, the reader will return to normal mode. When a reader leaves programming mode it is indicated by a blinking red LED and a beep.

16

Configuring the reader

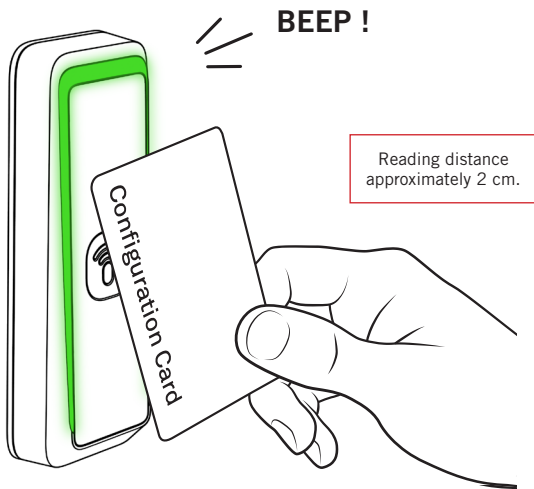

1: Set the reader in programming mode, see page: 16

2: Present the "Configuration Card" to the reader as shown. Keep the card within reading distance until the reader beeps and blinks in green. The reader is now programmed and ready for use according to the configuration settings on the configuration card.

17

Changing authentication card

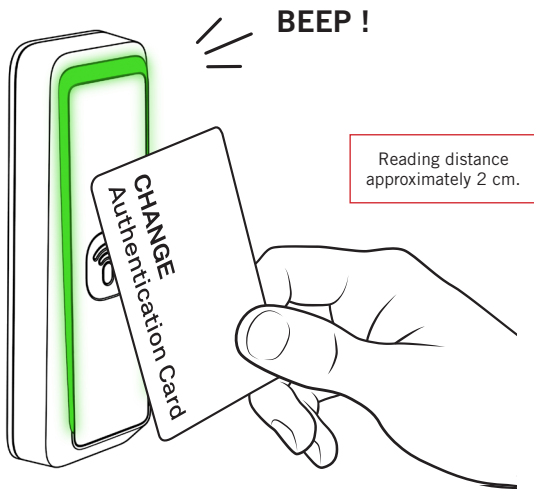

1: Set the reader in programming mode, see page: 16

2: Present the "CHANGE Authentication Card" to the reader as shown. Keep the card within reading distance until the reader beeps and blinks in green. The reader is now reprogrammed to only be set in programming mode by the new "Authentication Card". The old "Authentication Card" is no longer authorized to set the reader in programming mode.

CIDRON

Accessories

Cidron Slimline E Reader

19

Distance plate, Slimline E

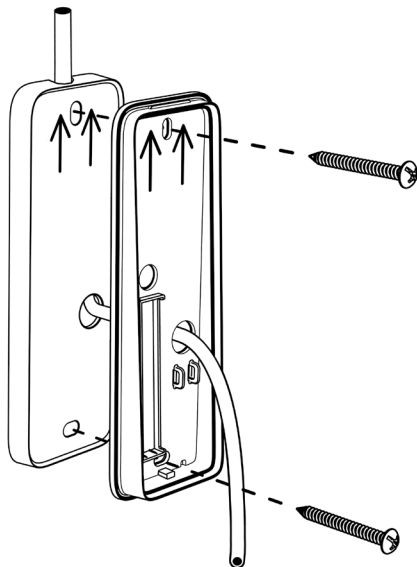

Matte black, pair
Matte white, part no: SC9291-V

The distance plate can be used for example when installing readers in environments where the installation surface is uneven or/and external wiring at the same side as the reader.

Distance plate, large, Slimline E

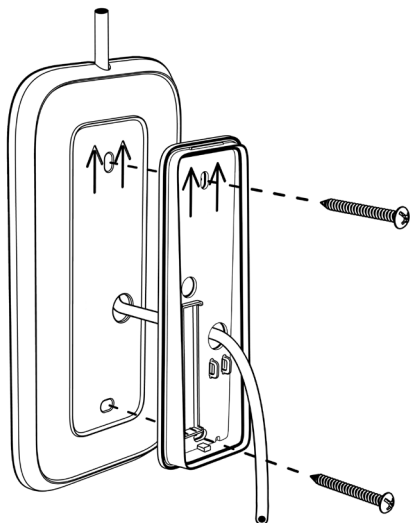

Matte black, part no: SC9297-S

Matte white, part no: SC9297-V

Used to install readers on an area where additional cover is needed to hide old installation holes or on uneven surfaces. Can also be used with external wiring on the same side as the reader.

21

Distance plate, angled 10° Slimline E

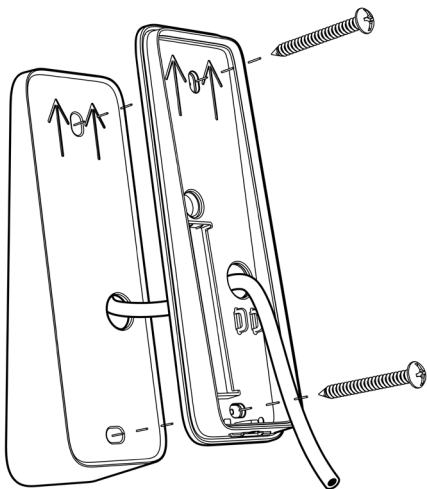

Matte black, part no: SC9293-S

Matte white, part no: SC9293-V

Used to increase accessibility as well as visibility of the keypad.

22

Distance plate, angled 33° Slimline E

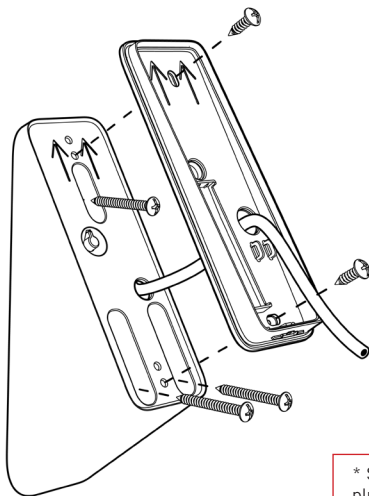

* Screws and screw
plugs included with
accessory.

Matte black, part no: SC9292-S

Used to increase accessibility as well as visibility of the keypad.
Recommended height is 900mm (center of reader) above the
ground/floor.

Vandalization protection Slimline E

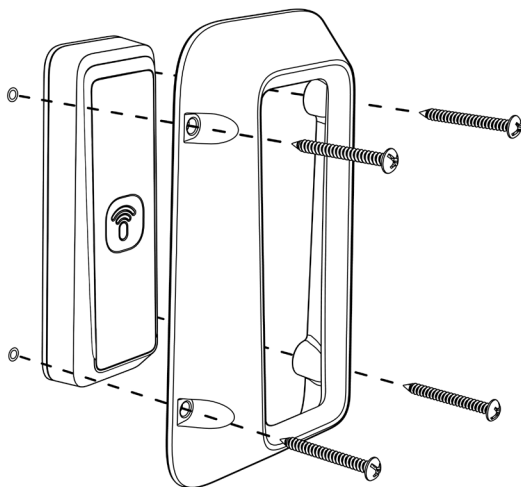

Matte black, part no: SC9280-S

* Screws and screw plugs included with accessory.

The vandalization protection is an accessory that shields the reader and helps it withstand violence by absorbing and redirecting external forces away from the reader. Can be retro-fitted to already installed readers.

Distance plate, large + Vandalization protection, Slimline E

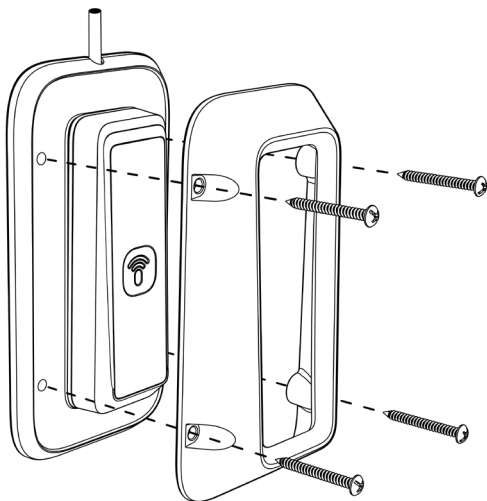

A recommended combination when external wiring is needed together with the vandalization protection. Can also be used for covering up old installation holes.

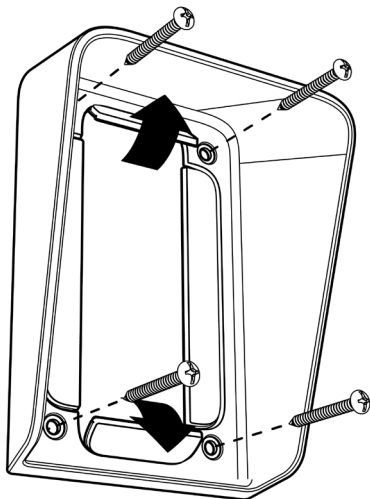

Transparent, part no: SC9901-T
White, part no: SC9901-V

* Screws and screw
plugs included with
accessory.

The transparent version SC9901-T is recommended to use for increased protection from rain and snow while still providing great visibility and accessibility in a slender format.

When installing readers in intense sunny conditions, the white version SC9901-V is recommended to use as a shading accessory to provide an environment for the reader without direct intense sunlight. In these conditions, it is also recommended to use white readers.

SC9901-V can also be used as PIN-privacy protection and/or increased climate protection.

When installing the climate- & privacy protection, use a pair of pliers to remove the plastic break-off parts to fit your reader model.

26

Cleaning instructions

Use compressed air in between the buttons to remove dust and dirt and after that Isopropyl alcohol can be used with a piece of fabric to rub in between the buttons and the reader exterior.

The Cidron readerfamily are intended for; Sale to professional security companies and installation by experienced security professionals. Seriline AB can not provide assurance that any entity or person buying or obtaining the product is properly experienced or trained to correctly install security related products including card readers.

SWEDEN

Seriline AB
Gustavslundsvägen 50
167 51 Bromma
Sweden

Tel: +46(0)10-150 75 00
info@seriline.com
seriline.com
